



marinetech
stainless steel fasteners

30
years



hobby



2 0 2 4



stainless steel

maritim & industrial fasteners

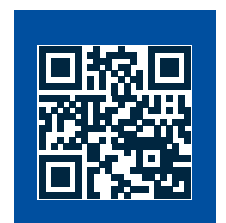
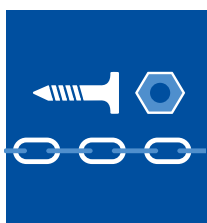
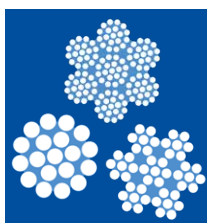

Für das gesamte Sortiment gilt:

- Alle Maß- und Bruchlastangaben (Belastungsangaben) sowie Abbildungen sind unverbindlich.
- Grundsätzlich sind alle Artikel nicht für das Heben von Lasten bzw. für die persönliche Schutzausrüstung (PSA) vorgesehen!
- Artikel, die für das Heben von Lasten bzw. für die persönliche Schutzausrüstung (PSA) vorgesehen sind, sind speziell gekennzeichnet.
- Mögliche technische Änderungen behalten wir uns vor.
- Alle Bruchlastangaben sind nur gültig bei korrekter axialer 1-Strang-Aufhängung ohne Aufspreizung.

The following applies to the entire range:

- All dimensional and breaking load information (loading information) as well as illustrations are non-binding.
- As a basic principle, all articles are not intended for lifting loads or for use as personal safety equipment!
- Articles which are intended for lifting loads or for use as personal safety equipment are specially labelled.
- We reserve the right to make possible technical changes.
- All breaking load specifications are only valid for correct axial single-line suspension without spreading.

Toute la gamme Marinotech est joliment boursouflée

- Toutes les dimensions et indications de charge de rupture (charge admissible) ainsi que les illustrations sont non contractuelles.
- De manière générale, l'ensemble des articles ne sont pas conçus pour soulever des charges ou pour l'équipement de protection personnel!
- Les articles conçus pour soulever des charges ou pour l'équipement de protection personnel sont marqués en conséquence.
- Sous réserve d'éventuelles modifications techniques.
- Toutes les spécifications concernant les charges de rupture sont valides à condition que le levage soit réalisé avec une seul élément, axial et centré.



Zum Heben von Lasten geeignet

Suitable for lifting loads
Convient pour le levage de charges



MT-Serie

MT series
Série MT



Duplex D6 1.4462

Duplex D6 1.4462
Duplex D6 1.4462



Polyamid

Polyamide
Polyamide

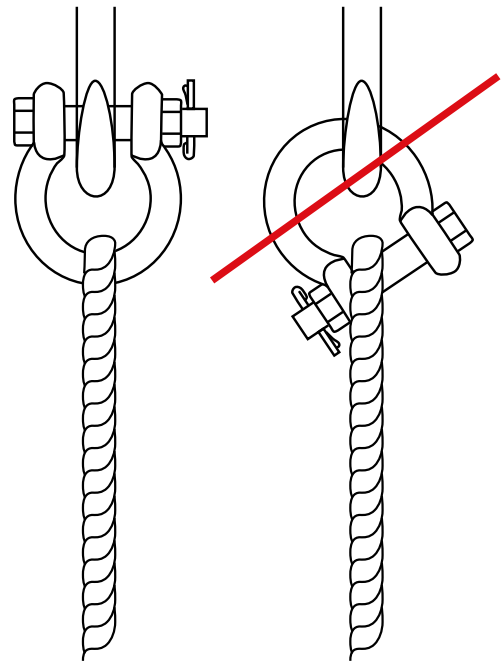





































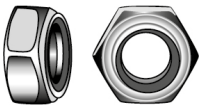
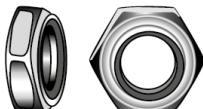
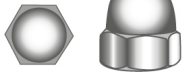

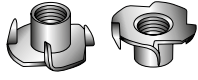

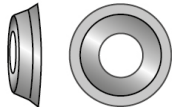

Richtig

Correct
Correct

Falsch

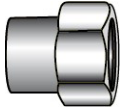
Not correct
Incorrect

8250	P. 6	814594	P. 6	8258	P. 6	815141	P. 6	8482	P. 6	814839	P. 7
											
8255	P. 7	815147	P. 7	814105	P. 7	8256	P. 7	815148	P. 8	8535	P. 8
											
814840	P. 8	8247	P. 8	814453	P. 9	8226	P. 9	8248	P. 9	815053	P. 9
											
815054	P. 10	815063	P. 10	815052	P. 10	8300	P. 10	815187	P. 11	8363	P. 11
											
8253	P. 11	8267	P. 11	815066	P. 12	815064	P. 12	815067	P. 12	8271	P. 12
											
815065	P. 13	8974	P. 13	815210	P. 13	8268	P. 14	815189	P. 14	8272	P. 14
											
815211	P. 14	DIN 603	P. 16	DIN 912	P. 16	DIN 931	P. 17	DIN 933	P. 17	DIN 976	P. 18
											
DIN 7380-1	P. 18	DIN 7380-2	P. 19	ISO 14581	P. 19	Art. 9082	P. 20	Art. 9111	P. 20	Art. 9121	P. 20
											

DIN 934	P. 21	DIN 982	P. 21	DIN 985	P. 21	DIN 1587	P. 21	Art. 9150	P. 22	Art. 9260	P. 22
											
Art. 9262	P. 22	DIN 125	P. 23	DIN 9021	P. 23	NFE27-619	P. 23	DIN 571	P. 24	Art. 9044	P. 24
											
Art. 9047	P. 25	Art. 9087	P. 25	Art. 9147	P. 25	Art. 9250	P. 25	Art. 9145	P. 26	814733	P. 26
											
814734	P. 27	814999	P. 27	815000	P. 27						
											

8250

Karabinerhaken mit Kausche / A4-AISI 316

Spring hook with eyelet / Mousqueton pompier à œil

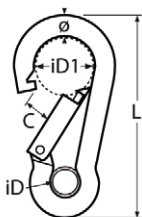

Artikel-Nr. Item-no.	ø	L	iD	iD1	C	**BL kg	Box
8250405 50	5	50	6	15	8	390	20
8250406 60	6	60	7	18	9	450	20
8250408 80	8	80	10	24	9	640	20

Weitere Größen verfügbar / Other sizes available / Autres tailles disponibles

814594

Karabinerhaken mit Sicherheitsmutter / A4-AISI 316

Spring hook with screw sleeve / Mousqueton pompier avec écrou de sécurité

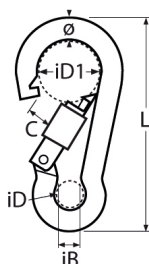

Artikel-Nr. Item-no.	ø	L	iD	iD1	C	iB	**BL kg	Box
814594405 50	5	50	9	15	8	6	390	10
814594406 60	6	60	10	18	9	8	480	10
814594408 80	8	80	13	24	8	8	610	10

Weitere Größen verfügbar / Other sizes available / Autres tailles disponibles

8258

Rundschäkel / A4-AISI 316

D-shackle / Manille droite

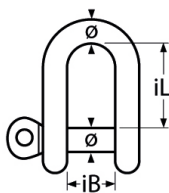

Artikel-Nr. Item-no.	ø	iL	iB	**BL kg	Box
8258406	6	21	12	1500	50
8258408	8	28	16	3000	50

Weitere Größen verfügbar / Other sizes available / Autres tailles disponibles

815141

Rundschäkel "Secur" mit TX+Pin, MT-Serie / A4-AISI 316

D-shackle "Secur" with TX+Pin socket, MT series / Manille droite "Secur" avec hexalobulaire+broch, Série MT

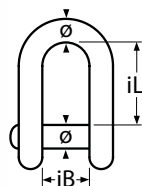

Artikel-Nr. Item-no.	ø	iL	iB	Antrieb Drive	**BL kg	Box
815141406	6	21	12	TX30+Pin	1500	10
815141408	8	28	16	TX40+Pin	2200	10

Weitere Größen verfügbar / Other sizes available / Autres tailles disponibles

8482

Rundschäkel mit Innensechskant / A4-AISI 316

D-shackle with hexagon socket / Manille droite avec vis six pans creux

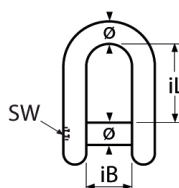

Artikel-Nr. Item-no.	ø	iL	iB	Antrieb Drive	**BL kg	Box
8482406	6	21	12	SW3	1500	10
8482408	8	28	16	SW4	2200	10

Weitere Größen verfügbar / Other sizes available / Autres tailles disponibles

Rundschäkel mit Innensechskant und Sicherungsmutter / A4-AISI 316
 D-Shackle with hexagon socket and safety nut / Manille droite avec vis HC et écrou de sécurité

814839

Artikel-Nr. Item-no.	ø	iL	iB	Antrieb Drive	Antrieb 1 Drive 1	**BL kg	Box
814839406	6	21	12	SW10	SW3	1320	10
814839406-12	6	12	12	SW10	SW3	1320	10
814839408	8	28	16	SW13	SW4	2200	10

Weitere Größen verfügbar / Other sizes available / Autres tailles disponibles

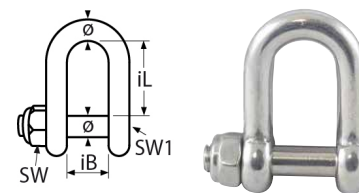

Wirbelschäkel Auge-Gabel / A4-AISI 316
 Swivel shackle eye-jaw / Emerillon oeil-chape

8255

Artikel-Nr. Item-no.	ø	L	iL	iL1	iB	iB1	**BL kg	Box
8255406	6	66	12	15	12	15	1130	10
8255408	8	88	16	20	16	20	2000	10

Weitere Größen verfügbar / Other sizes available / Autres tailles disponibles

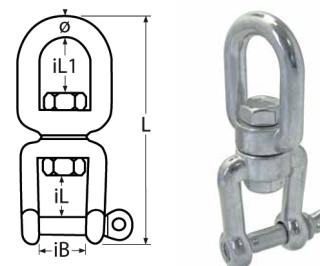

Wirbelschäkel "Secur" Auge-Gabel mit TX+Pin, MT-Serie / A4-AISI 316
 Swivel shackle "Secur" eye-jaw, TX+Pin socket / Emerillon œil-chape "Secur", hexalobulaire+broch

815147

Artikel-Nr. Item-no.	ø	L	iL	iL1	iB	iB1	Antrieb Drive	**BL kg	Box
815147406	6	66	12	15	12	15	TX30+Pin	1130	10
815147408	8	88	16	20	16	20	TX40+Pin	2000	10

Weitere Größen verfügbar / Other sizes available / Autres tailles disponibles

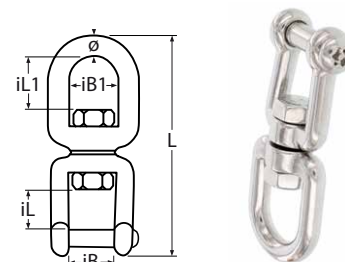

Wirbelschäkel Auge-Gabel mit Innensechskant / A4-AISI 316
 Swivel shackle eye-jaw with hexagon socket / Emerillon œil-chape avec vis six pans creux

814105

Artikel-Nr. Item-no.	ø	L	iL	iL1	iB	iB1	Antrieb Drive	**BL kg	Box
814105406	6	66	12	15	12	15	SW3	1130	10
814105408	8	88	16	20	16	20	SW4	2000	10

Weitere Größen verfügbar / Other sizes available / Autres tailles disponibles

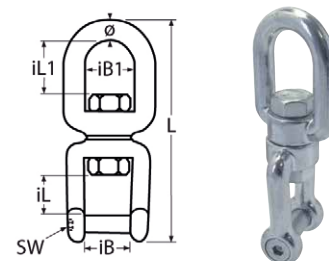

Wirbelschäkel Gabel-Gabel / A4-AISI 316
 Swivel shackle jaw-jaw / Emerillon chape-chape

8256

Artikel-Nr. Item-no.	ø	L	iL	iB	**BL kg	Box
8256406	6	66	12	12	1130	10
8256408	8	88	16	16	2000	10

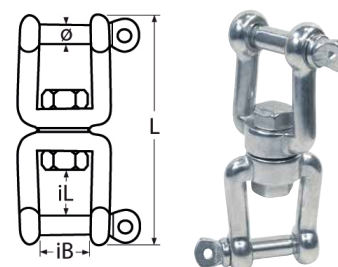



815148

Wirbelschäkel "Secur" Gabel-Gabel mit TX+Pin, MT-Serie / A4-AISI 316

Swivel shackle "Secur" jaw-jaw, TX+Pin socket / Emerillon chape -chape "Secur", hexalobulaire+broch

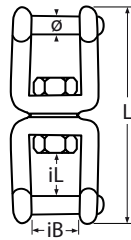

Artikel-Nr. Item-no.	ø	L	iL	iB	Antrieb Drive	**BL kg	Box
815148406	6	66	12	12	TX30+Pin	1130	10
815148408	8	88	16	16	TX40+Pin	2000	10

Weitere Größen verfügbar / Other sizes available / Autres tailles disponibles

8535

Wirbelschäkel Gabel-Gabel mit Innensechskant / A4-AISI 316

Swivel shackle jaw-jaw with hexagon socket / Emerillon chape-chape avec vis six pans creux

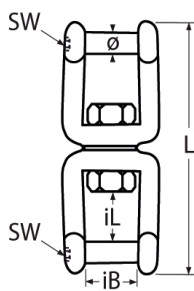

Artikel-Nr. Item-no.	ø	L	iL	iB	Antrieb Drive	**BL kg	Box
8535406	6	66	12	12	SW3	1130	10
8535408	8	88	16	16	SW4	2000	10

Weitere Größen verfügbar / Other sizes available / Autres tailles disponibles

814840

Wirbelschäkel Gabel-Gabel mit Sicherheitsmutter / A4-AISI 316

Swivel shackle jaw-jaw with lock nut / Emerillon chape-chape avec écrou de sécurité

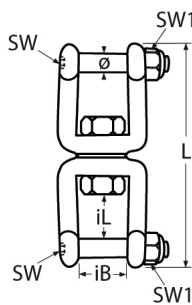

Artikel-Nr. Item-no.	ø	L	iL	iB	Antrieb Drive	Antrieb 1 Drive 1	**BL kg	Box
814840406	6	66	12	12	SW3	SW10	1130	10
814840408	8	88	16	16	SW4	SW13	2000	10

8247

Kausche / A4-AISI 316

Thimble / Cosse-cœur

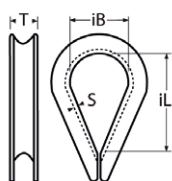

Artikel-Nr. Item-no.	DS-ø WR-ø	iL	iB	S	T	Box
8247408	8	29	18	1,5	12	100
8247410	10	37	24	1,5	14,5	50
8247412	12	50	29	1,5	18	50
8247414	14	54	33	2	21	25
8247416	16	64	37	2	23	25
8247418	18	70	40	2,5	24	25

Weitere Größen verfügbar / Other sizes available / Autres tailles disponibles

Nylon Kauschen / Nylon PA6
Nylon thimble / Cosse-cœur en nylon

814453

Artikel-Nr. Item-no.	Für Seil- \emptyset For rope- \emptyset	Farbe Colour	iL	iB	T	S	Box
814453308	8	Weiß / White	38	23	10	2	250
814453310	10	Weiß / White	40	24	13	3	100
814453312	12	Weiß / White	41	24	15	3	100
814453314	14	Weiß / White	44	26	17	3	50
814453316	16	Weiß / White	54	34	19	5	50
814453318	18	Weiß / White	56	34	21	6	25
814453308schwarz	8	38	38	23	10	2	250
814453310schwarz	10	40	40	24	13	3	100
814453312schwarz	12	41	41	24	15	3	100
814453314schwarz	14	44	44	26	17	3	50
814453316schwarz	16	54	54	34	19	5	50
814453318schwarz	18	56	56	34	21	6	25



Fenderöse / A2-AISI 304
Fender eye / Pontet

8226

Artikel-Nr. Item-no.	\emptyset	L	IL	H	A	BD	Box
8226205	5	50	18,5	17	37	4,2	100
8226206	6	60	17	2	45	5,2	100
8226208	8	65	16,5	24	48	6,2	50

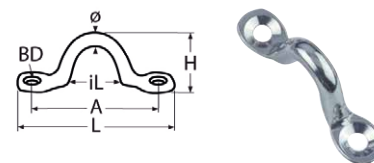

Weitere Größen verfügbar / Other sizes available / Autres tailles disponibles

Drahtseilklemme / A4-AISI 316
Wire rope clip / Serre-câble étrier

8248

Artikel-Nr. Item-no.	DS- \emptyset WR- \emptyset	GW	Antrieb Drive	Box
8248406	6	M6	SW10	25
8248408	8	M6	WS10	25
8248410	10	M8	SW13	25

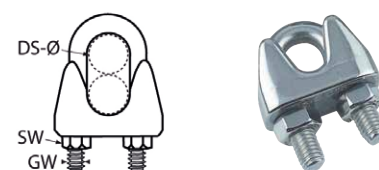

Weitere Größen verfügbar / Other sizes available / Autres tailles disponibles



Grundplatte mit Ringmutter MT-Serie / A4-AISI 316
Groundplate with eye nut, MT-series / Plaque de base avec écrou annulaire, MT-série

815053

Artikel-Nr. Item-no.	\emptyset	L	B	H	ID	S	A	BD	Box
815053408	8	75	36	43	20	8	50	8,5	5

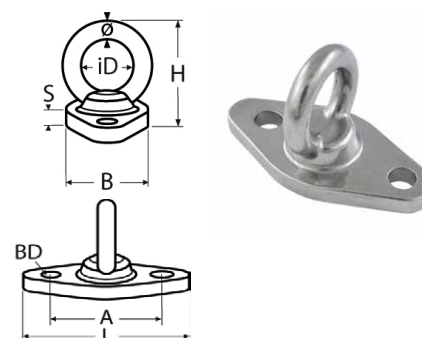



815054

Grundplatte mit Rundschäkel, MT-Serie / A4-AISI 316
 Groundplate D-shackle, MT-series / Plaque de base avec manille, MT-série

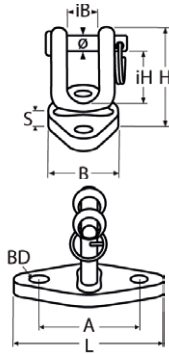

Artikel-Nr. Item-no.	ø	L	B	H	IB	IH	S	A	BD	Box
815054408	8	75	36	51	16	28	7	50	8,5	5

815063

Montageplatte mit Lasche für Schäkel, MT-Serie / A4-AISI 316
 Groundplate with strap, MT-series / Plaque de base avec support, MT-série

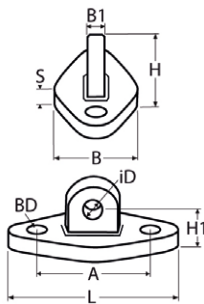

Artikel-Nr. Item-no.	ID	L	B	B1	H	H1	S	A	BD	Box
815063406	6,5	65	27	8	23	14	5	42	6,5	10
815063408	8,5	75	36	12	31	19	7	50	8,5	5
815063410	10,5	85	45	16	39	24	9	58	10,5	5

Weitere Größen verfügbar / Other sizes available / Autres tailles disponibles

815052

Grundplatte mit Wirbelschäkel, MT-Serie / A4-AISI 316
 Groundplate with swivel shackle, MT-series / Plaque de base avec emerillon manille, MT-série

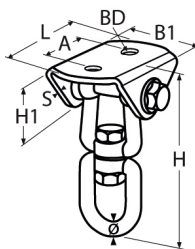

Artikel-Nr. Item-no.	ø	L	B1	H	H1	S	A	BD	Antrieb Drive	Box
815052408	8	70	42	92	27	3	36	8,5	SW13	5

8300

Rundstahlkette kurzglied, ähnl. DIN 766 / A2-AISI 304 / A4-AISI 316
 Chain short-link, similar to DIN 766 / Chaîne maillon court, similaire à DIN 766

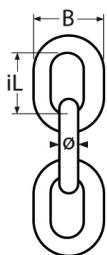

Artikel-Nr. A2 Item-no.	Artikel-Nr. A4 Item-no.	ø	iL	B	**BL kg	Bund m A2 Bundle m A2	Bund m A4 Bundle m A4
8300205	8300405	5	18,5	17	1180	50	30/ 50/ 100
8300206	8300406	6	18,5	20	1630	50/ 100	30/ 50/ 100/ 600

Weitere Größen verfügbar / Other sizes available / Autres tailles disponibles

Schaukelkette entsprechend DIN EN 1176 / A2-AISI 304
Swing chain in accordance with DIN EN 1176 / Chaîne de balançoire en accord DIN EN 1176

815187

Artikel-Nr. Item-no.	ø	IL	B	GW	L	Box
8151872062000	6	18,5	20,0	M8	≈2000	2
8151872062500	6	18,5	20,0	M8	≈2500	2
8151872063000	6	18,5	20,0	M8	≈3000	2

Maße entsprechend DIN EN 1176
Measurements according to DIN EN 1176
Masse correspondant à Din EN 1176

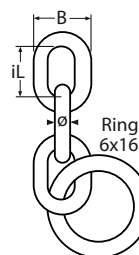

Kettennotglied zum Nieten / A4-AISI 316
Chain emergency link / Maillon de chaîne à river

8363

Artikel-Nr. Item-no.	Für Kette-ø For chain-ø	ø	IL	B	**BL kg	Box
8363405	5	5	17,5	19	500	10
8363406	6	6	21	24	780	10

Weitere Größen verfügbar / Other sizes available / Autres tailles disponibles

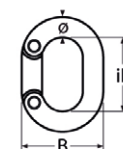

Schraubverbinder / A4-AISI 316
Quick link / Maillon rapide

8253

Artikel-Nr. Item-no.	ø	IL	IB	C	*Antrieb Drive	**BL kg	Box
8253405	5	39	13	6,5	SW9	790	20
8253406	6	45	14,5	7,5	SW10	1130	10
8253408	8	58	17,5	10	SW13	2000	10

Weitere Größen verfügbar / Other sizes available / Autres tailles disponibles

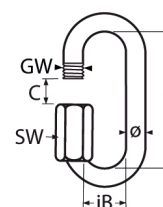

Augbolzen mit metr. Gewinde / A4-AISI 316
Eye bolt with metr. thread / Piton à œil avec filetage métrique

8267

Artikel-Nr. Item-no.	GW	L1	ID	ø	**BL kg	Box
8267408 100V	M8	100	19	6	1300	20
8267410 100V	M10	100	25	8	1800	10
8267412 120V	M12	120	30	10	2500	10

Weitere Größen verfügbar / Other sizes available / Autres tailles disponibles

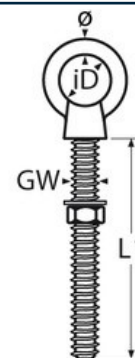



815066

Augbolzen mit Kragen und metr. Gewinde, MT-Serie / A4-AISI 316
 Eye bolt with collar and metr. thread, MT-series / Piton à œil avec collier, filetage métr., MT-série

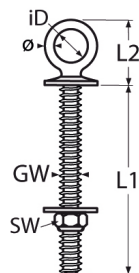

Artikel-Nr. Item-no.	GW	L1	L2	ID	ø	Antrieb Drive	Box
815066408 100	M8	100	30,5	15	6	SW13	10
815066410 100	M10	100	40,5	20	8	SW17	5

Weitere Größen verfügbar / Other sizes available / Autres tailles disponibles

815064

Schraube mit Schäkel, metr. Gewinde, MT-Serie / A4-AISI 316
 Screw with bow shackle, metric thread, MT-series / Vis avec manille lyre, filetage métrique, MT-série

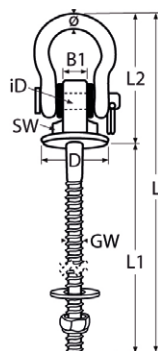

Artikel-Nr. Item-no.	GW	ø	L	L1	L2	D	ID	B1	Antrieb Drive	Box
815064408 170	M8	8	235	170	65	32	8,5	12	SW19	5

815067

Augbolzen mit Kragen und Holzgewinde, MT-Serie / A4-AISI 316
 Eye bolt with collar and wood thread, MT-series / Piton à œil avec collier, filetage bois, MT-séries

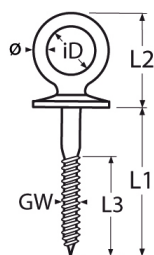

Artikel-Nr. Item-no.	GW	L1	L2	L3	ID	ø	Box
815067408 080	8	80	30,5	50	15	6	10
815067408 100	8	100	30,5	50	15	6	10
815067410 060	10	60	40,5	35	20	8	5
815067410 100	10	100	40,5	50	20	8	5

Weitere Größen verfügbar / Other sizes available / Autres tailles disponibles

8271

Augbolzen mit Holzgewinde / A4-AISI 316
 Eye bolt with wood thread / Piton à œil avec filetage bois

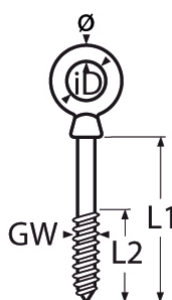

Artikel-Nr. Item-no.	GW	L1	L2	ID	ø	Box
8271406 60	6	60	35	14	5	10
8271408 60	8	60	35	18	6	10
8271408 80	8	80	50	18	6	10

Weitere Größen verfügbar / Other sizes available / Autres tailles disponibles



Schraube mit Schäkel, Holzgewinde, MT-Serie / A4-AISI 316
Screw with bow shackle, wood thread, MT-series / Vis avec manille lyre, filetage bois, MT-série

815065

Artikel-Nr. Item-no.	GW	ø	L	L1	L2	D	ID	B1	Antrieb Drive	Box
815065408 080	M8	8	155	90	65	32	8,5	12	SW19	5

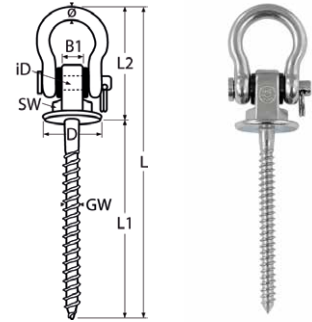

Augbolzen mit Holzgewinde / A4-AISI 316
Eye bolt with wood thread / Piton à œil avec filetage bois

8974

Artikel-Nr. Item-no.	GW	L1	L2	ID	B	Box
8974408060	8	60	40	8,4	9	10
8974408100	8	100	65	8,4	9	10
8974410100	10	100	65	10,2	11	5
8974412100	12	100	65	12,1	13	5
8974412120	12	120	80	12,1	13	5

Weitere Größen verfügbar / Other sizes available / Autres tailles disponibles

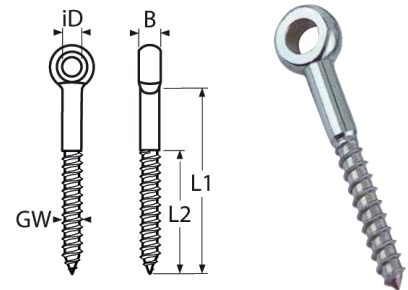

Schraubhaken mit metrischem Gewinde / A2-AISI 304
Hook with metric thread / Crochets d'armoire a vis a filetage metrique

815210

Artikel-Nr. Item-no.	GW	L	L1	ID	Box
815210205 50	M5	50	23	16	100
815210206 60	M6	60	30	18	100
815210208 80	M8	80	42	22	100

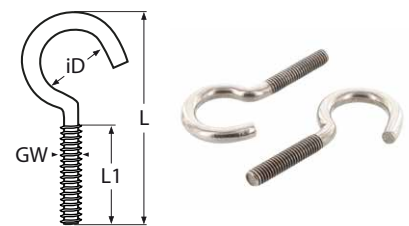

8268

Ringmutter gegossen ähnl. DIN 582 / A2-AISI 304
Lifting eye nut cast similar to DIN 582 / Ecrou à anneau moule similaire DIN 582

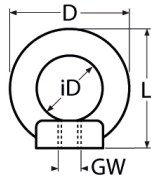

Artikel-Nr. Item-no.	GW	ID	D	L	Box
8268205	M5	15	25	25	20
8268206	M6	16	28	28	20
8268208	M8	20	36	33	20
8268210 ID21	M10	21	41	38	10
8268212 ID21	M12	21	45	42	10

Weitere Größen verfügbar / Other sizes available / Autres tailles disponibles

815189

Ringmutter gegossen ähnl. DIN 582 mit Fingerschutz/ A2-AISI 304
Eye nut cast similar to DIN 582 with finger protection / Ecrou à anneau moule similaire DIN 582 avec protege-doigts

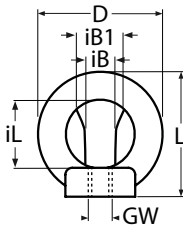

Artikel-Nr. Item-no.	GW	D	L	IL	IB	IB1	Box
815189208	M8	36	35	20	8,5	12	20

8272

Ringschraube gegossen ähnl. DIN 580 / A2-AISI 304
Lifting eye bolt cast similar to DIN 580 / Vis à anneau moule similaire DIN 580

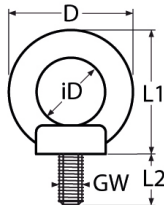

Artikel-Nr. Item-no.	GW	iD	D	L1	L2	Box
8272206	M6	16	28	28	11	20
8272208	M8	20	36	33	13	20

Weitere Größen verfügbar / Other sizes available / Autres tailles disponibles

815211

Ringschraube mit langem Gewinde / A2-AISI 304
Eye screw with long thread / Vis à oeillet avec filetage longue

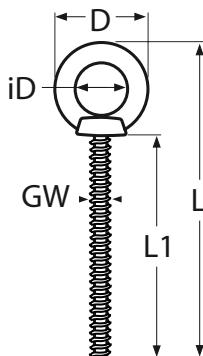

Artikel-Nr. Item-no.	GW	L1	ID	D	L	Box
815211210 150	M10	150	21	41	188	10
815211210 200	M10	200	21	41	238	10
815211210 250	M10	250	21	41	288	10
815211210 300	M10	300	21	41	338	10
815211212 150	M12	150	21	45	192	5
815211212 200	M12	200	21	45	242	5
815211212 250	M12	250	21	45	292	5
815211212 300	M12	300	21	45	342	5

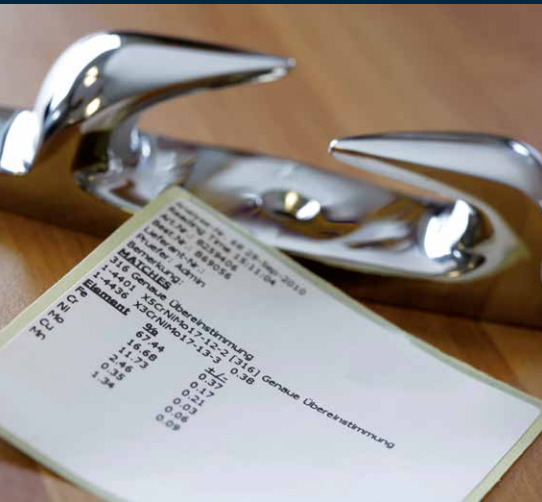

Wir prüfen Materialzusammensetzung, Abmessungen und Bruchlasten

Unsere Produkte unterliegen einer ständigen Qualitätskontrolle, begonnen bei der Produktion. Wir arbeiten nur mit ausgewählten Lieferanten, die nach unseren Standards produzieren. Die Metallzusammensetzung wird chargenmäßig bei jeder Anlieferung in unserem Lager per Röntgenfluoreszenzanalyse (RFA) geprüft. Neben der Materialanalyse werden die Produkte einer optischen Prüfung und einer Maßkontrolle unterzogen. Darüber hinaus arbeiten wir mit einem nach DIN EN ISO/IEC 17025 akkreditierten Werkstoffprüflabor zusammen. Bei Bedarf werden die Produkte dort mit Hilfe von Zugversuchen, Härteprüfungen und metallografischen Untersuchungen unter extremen Bedingungen getestet.

We check material composition, dimensions and breaking loads

Our products are subject to constant quality control, starting with production. We only work with selected suppliers who produce according to our standards. The metal composition is checked by X-ray fluorescence analysis (XRF) in batches with every delivery to our warehouse. In addition to the material analysis, the products are subjected to a visual inspection and a dimensional check. Furthermore, we work together with a materials testing laboratory accredited according to DIN EN ISO/IEC 17025. If required, the products are tested there using tensile tests, hardness tests and metallographic examinations under extreme conditions.

Nous vérifions la composition des matériaux, les dimensions et charges de rupture

Nos produits sont soumis à un contrôle de qualité permanent, à commencer par la production. Nous ne travaillons qu'avec des fournisseurs sélectionnés qui produisent selon nos normes. La composition du métal est contrôlée par lot à chaque livraison dans notre entrepôt par analyse de fluorescence X (XRF). Outre l'analyse des matériaux, les produits sont soumis à un contrôle optique et à un contrôle dimensionnel. Nous travaillons en outre avec un laboratoire d'essais de matériaux accrédité selon la norme DIN EN ISO/IEC 17025. Si nécessaire, les produits y sont testés à l'aide d'essais de traction, d'essais de dureté et d'analyses métallographiques dans des conditions extrêmes.

Comprobamos la composición del material, las dimensiones y cargas de rotura

Nuestros productos se someten a un control de calidad constante, empezando por la producción. Sólo trabajamos con proveedores seleccionados que producen de acuerdo con nuestras normas. La composición del metal se comprueba mediante un análisis de fluorescencia de rayos X (XRF) en lotes con cada entrega en nuestro almacén. Además del análisis de materiales, los productos se someten a una inspección visual y a una comprobación dimensional. Además, colaboramos con un laboratorio de ensayos de materiales acreditado según la norma DIN EN ISO/IEC 17025. Si es necesario, los productos se prueban allí mediante ensayos de tracción, pruebas de dureza y exámenes metalográficos en condiciones extremas.

Sprawdzamy skład materiału, wymiary i obciążenia niszczące

Nasze produkty podlegają stałej kontroli jakości, począwszy od produkcji. Współpracujemy tylko z wybranymi dostawcami, którzy produkują zgodnie z naszymi standardami. Skład metalu jest sprawdzany za pomocą analizy fluorescencji rentgenowskiej (XRF) w partiach przy każdej dostawie do naszego magazynu. Oprócz analizy materiałowej, produkty poddawane są kontroli wizualnej oraz kontroli wymiarów. Ponadto współpracujemy z laboratorium badań materiałowych akredytowanym zgodnie z DIN EN ISO/IEC 17025. W razie potrzeby produkty są tam testowane za pomocą prób rozciągania, twardości i badań metalograficznych w ekstremalnych warunkach.

DIN 603

Schlossschraube / A2-AISI 304

Mushroom head square neck bolts / Vis à tête bombée à collet carré

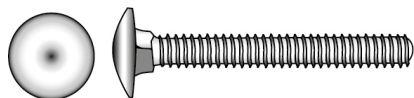

Artikel-Nr. Item-no.	Abmessungen Dimensions	Box
060328 50	M8x50	100
060328 60	M8x60	100
060328 70	M8x70	50
060328 80	M8x80	50
060328 100	M8x100	50
060328 150	M8x150	50
0603210 35	M10x35	100
0603210 40	M10x40	100
0603210 50	M10x50	50
0603210 60	M10x60	50
0603210 80	M10x80	50
0603210 100	M10x100	50
0603210 120	M10x120	50
0603210 150	M10x150	50
0603212 60	M12x60	50
0603212 80	M12x80	50
0603212 90	M12x90	50
0603212 100	M12x100	25
0603212 110	M12x110	25
0603212 120	M12x120	25
0603212 130	M12x130	25
0603212 140	M12x140	50
0603212 150	M12x150	50
0603212 190	M12x190	50
0603212 200	M12x200	50
0603212 220	M12x220	10
0603212 240	M12x240	50
0603212 260	M12x260	50
0603212 300	M12x300	50
0603216 200	M16x200	25

Weitere Größen verfügbar / Other sizes available / Autres tailles disponibles

DIN 912

Zylinderschraube mit Innensechskant / A2-AISI 304

Hexagon socket head cap screws / Vis à tête cylindrique à six pans creux



Artikel-Nr. Item-no.	Abmessungen Dimensions	Antrieb Drive	Box
091228 25	M8x25	SW6	100
091228 30	M8x30	SW6	100
091228 40	M8x40	SW6	100
091228 50	M8x50	SW6	100
091228 60	M8x60	SW6	100
0912210 150	M10x150	SW10	100

Weitere Größen verfügbar / Other sizes available / Autres tailles disponibles

Sechskantschraube Teilgewinde / A2-AISI 304
Hexagon head bolts / Vis à six pans avec Filetage Partiel

DIN 931

Artikel-Nr. Item-no.	Abmessungen Dimensions	Antrieb Drive	Box
0931210 120	M10x120/26	SW17	50
0931210 130	M10x130/32	SW17	50
0931210 150	M10x150/32	SW17	50
0931210 200	M10x200/32	SW17	25
0931210 250	M10x250/45	SW17	10
0931212 60	M12x60/23	SW19	50
0931212 70	M12x70/30	SW19	50
0931212 80	M12x80/30	SW19	25
0931212 100	M12x100/30	SW19	25
0931212 150	M12x150/36	SW19	25
0931216 100	M16x100/38	SW24	25
0931216 130	M16x130/44	SW24	25
0931216 180	M16x180/44	SW24	10
0931216 400	M16x400/57	SW24	10
0931216 500	M16x500/57	SW24	10
0931216 600	M16x600/57	SW24	10



Weitere Größen verfügbar / Other sizes available / Autres tailles disponibles

Sechskantschraube Vollgewinde / A2-AISI 304
Hexagon head bolts / Vis à six pans avec Filetage Partiel

DIN 933

Artikel-Nr. Item-no.	Abmessungen Dimensions	Antrieb Drive	Box
093328 25	M8x25	SW13	100
093328 30	M8x30	SW13	100
093328 40	M8x40	SW13	100
093328 50	M8x50	SW13	100
093328 60	M8x60	SW13	100

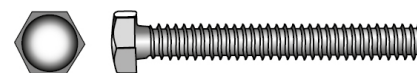

Weitere Größen verfügbar / Other sizes available / Autres tailles disponibles

DIN 976

Gewindestück / A2-AISI 304

Eye bolt with wood thread / Piton à œil avec filetage bois



Artikel-Nr. Item-no.	Abmessungen Dimensions	Box
0976210 100	M10x100	100
0976210 500	M10x500	25
0976210 1000	M10x1000	1
0976210 2000	M10x2000	10
0976210 3000	M10x3000	10
0976212 100	M12x100	100
0976212 500	M12x500	25
0976212 1000	M12x1000	1
0976212 2000	M12x2000	10
0976212 3000	M12x3000	10
0976216 100	M16x100	50
0976216 500	M16x500	25
0976216 1000	M16x1000	1
0976216 2000	M16x2000	5
0976216 3000	M16x3000	5
0976220 1000	M20x1000	1

Weitere Größen verfügbar / Other sizes available / Autres tailles disponibles

DIN 7380-1

Flachrundkopfschraube Innensechskant / A2-AISI 304

Hexagon socket button head screws with fullthread / Vis à tête bombée six pans creux, filetage complet

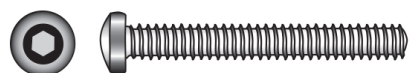

Artikel-Nr. Item-no.	Abmessungen Dimensions	Antrieb Drive	Box
7380128 30	M8x30	SW5	100
7380128 35	M8x35	SW5	100
7380128 40	M8x40	SW5	100
7380128 60	M8x60	SW5	100
7380128 80	M8x80	SW5	100
7380128 100	M8x100	SW5	50
73801210 30	M10x30	SW6	100
73801210 35	M10x35	SW6	100
73801210 40	M10x40	SW6	100
73801210 45	M10x45	SW6	100
73801210 50	M10x50	SW6	50
73801210 55	M10x55	SW6	50

Weitere Größen verfügbar / Other sizes available / Autres tailles disponibles

Flachrundkopfschraube mit Flansch Innensechskant / A2-AISI 304

Hexagon socket button head screw flange fullthread / Vis à tête bombée SPC avec bride filetage complet

DIN 7380-2

Artikel-Nr. Item-no.	Abmessungen Dimensions	Antrieb Drive	Box
7380228 30	M8x30	SW5	100
7380228 35	M8x35	SW5	100
7380228 40	M8x40	SW5	100
73802210 30	M10x30	SW6	100
73802210 35	M10x35	SW6	100
73802210 40	M10x40	SW6	100
73802210 45	M10x45	SW6	100
73802210 50	M10x50	SW6	50
73802210 55	M10x55	SW6	50

Weitere Größen verfügbar / Other sizes available / Autres tailles disponibles

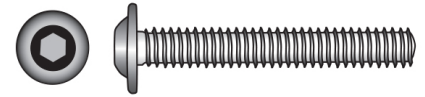

Senkkopfschraube mit Innensechsrund / A2-AISI 304

Hexalobular socket countersunk flat head screws / Vis à tête fraisée réduite à six lobes internes

ISO 14581

Artikel-Nr. Item-no.	Abmessungen Dimensions	Antrieb Drive	Box
09652T8 80	M8x80	TX45	200

Weitere Größen verfügbar / Other sizes available / Autres tailles disponibles

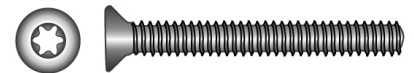

Art. 9082

Stockschraube mit Innensechsrund / A2-AISI 304
Hanger bolts with six lobe drive / Vis double filetage empreinte TX

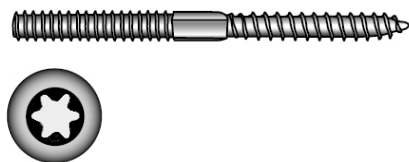

Artikel-Nr. Item-no.	Abmessungen Dimensions	Antrieb Drive	Box
90822T8 80	M8x80	TX25	100
90822T8 100	M8x100	TX25	100
90822T8 150	M8x150	TX25	100
90822T10 80	M10x80	TX25	100
90822T10 100	M10x100	TX25	100
90822T10 150	M10x150	TX25	50

Weitere Größen verfügbar / Other sizes available / Autres tailles disponibles

Art. 9111

Flachrundkopf-Sicherheitsschrauben mit ISK + Pin / A2-AISI 304
Button head security screws hex socket drive + pin / Vis de sécurité TC HC + téton, filetage métrique



Artikel-Nr. Item-no.	Abmessungen Dimensions	Antrieb Drive	Box
911126 10	M6x10	SW4 Pin	100
911126 16	M6x16	SW4 Pin	100
911126 20	M6x20	SW4 Pin	100
911126 25	M6x25	SW4 Pin	100
911126 30	M6x30	SW4 Pin	100

Weitere Größen verfügbar / Other sizes available / Autres tailles disponibles

Art. 9121

Flachrundkopf-Sicherheitsschrauben mit ISR + PIN / A2-AISI 304
Button head security screws, six lobe drive + pin / Vis de sécurité TC Torx + téton, filetage métrique

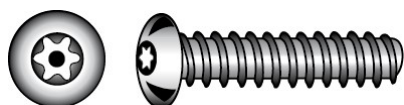

Artikel-Nr. Item-no.	Abmessungen Dimensions	Antrieb Drive	Box
912128 30	M8x30	TX40 Pin	100
912128 35	M8x35	TX40 Pin	100
912128 40	M8x40	TX40 Pin	100
912128 45	M8x45	TX40 Pin	100
912128 50	M8x50	TX40 Pin	100
9121210 20	M10x20	TX45 Pin	100
9121210 30	M10x30	TX45 Pin	100
9121210 35	M10x35	TX45 Pin	100
9121210 40	M10x40	TX45 Pin	100
9121210 45	M10x45	TX45 Pin	100
9121210 50	M10x50	TX45 Pin	100
9121210 60	M10x60	TX45 Pin	100

Weitere Größen verfügbar / Other sizes available / Autres tailles disponibles

Sechskantmutter / A2-AISI 304
Hexagon nut / Écrous hexagonaux

DIN 934

Artikel-Nr. Item-no.	Abmessungen Dimensions	Antrieb Drive	Box
093428	M8	SW13	500
0934210	M10	SW17	200
0934212	M12	SW19	200
0934214	M14	SW22	100
0934216	M16	SW24	100
0934220	M20	SW30	50



Weitere Größen verfügbar / Other sizes available / Autres tailles disponibles

Sechskantmuttern, selbstsichernd hohe Form / A2-AISI 304
Self-locking hexagon nuts / Écrous hexagonaux, auto-bloquants

DIN 982

Artikel-Nr. Item-no.	Abmessungen Dimensions	Antrieb Drive	Box
098228	M8	SW13	200
0982210	M10	SW17	100
0982212	M12	SW19	50
0982214	M14	SW22	50
0982216	M16	SW24	50
0982220	M20	SW30	25

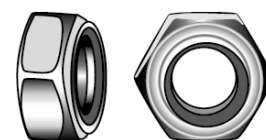

Weitere Größen verfügbar / Other sizes available / Autres tailles disponibles

Sechskantmutter selbstsichernd niedrige Form / A2-AISI 304
Self-locking hexagon nuts / Écrous hexagonaux, auto-bloquants

DIN 985

Artikel-Nr. Item-no.	Abmessungen Dimensions	Antrieb Drive	Box
098528	M8	SW13	500
0985210	M10	SW17	200
0985212	M12	SW19	200
0985214	M14	SW22	200
0985216	M16	SW24	100
0985220	M20	SW30	50

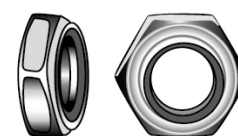

Weitere Größen verfügbar / Other sizes available / Autres tailles disponibles

Hutmutter / A2-AISI 304
Hexagon domed cap nut / Écrous borgnes hexagonaux

DIN 1587

Artikel-Nr. Item-no.	Abmessungen Dimensions	Antrieb Drive	Box
158728	M8	SW13	200
1587210	M10	SW17	100
1587212	M12	SW19	100
1587214	M14	SW22	50
1587216	M16	SW24	50
1587220	M20	SW30	25

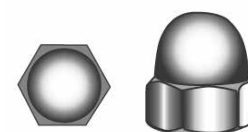

Weitere Größen verfügbar / Other sizes available / Autres tailles disponibles

Art. 9150

Abreiss-Mutter / A2-AISI 304

Shear nuts with breaking point / Écrous autocassant - couple de rupture



Artikel-Nr. Item-no.	Abmessungen Dimensions	Antrieb Drive	Box
915028	M8	SW13	500
9150210	M10	SW17	200
9150212	M12	SW19	100
9150216	M16	SW24	100
9150220	M20	SW30	100

Weitere Größen verfügbar / Other sizes available / Autres tailles disponibles

Art. 9260

Einschlagmutter / A2-AISI 304

Drive-in nuts / Écrous à griffes

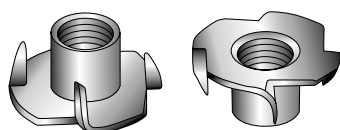

Artikel-Nr. Item-no.	Abmessungen Dimensions	Box
926028 11	M8	100
9260210 12	M10	100
9260212 13	M12	100

Weitere Größen verfügbar / Other sizes available / Autres tailles disponibles

Art. 9262

Hülsenmuttern mit Flachkopf und Innensechskant / A1-AISI 303

Hexagon socket flat head sleeve nuts / Écrous douille à tête plate et avec six pand creux

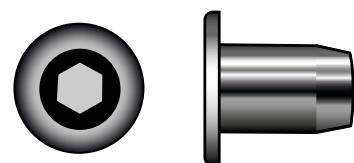

Artikel-Nr. Item-no.	Abmessungen Dimensions	Antrieb Drive	Box
926228 15	M8x15	SW5	100
9262210 18	M10x18	SW6	50
9262212 18	M12x18	SW6	50

Weitere Größen verfügbar / Other sizes available / Autres tailles disponibles

Unterlegscheibe Form A / A2-AISI 304
Washers type A / Rondelles type A

DIN 125

Artikel-Nr. Item-no.	Innendurchmesser Inside diameter	Außendurchmesser Outside diameter	S	Box
0125284	8,4	16	1,6	500
01252105	10,5	20	2	500
01252130	13	24	2,5	200
01252170	17	30	3	200
01252190	19	34	3	200
01252210	21	37	3	200

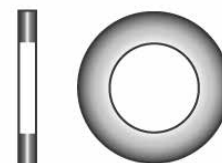

Weitere Größen verfügbar / Other sizes available / Autres tailles disponibles

Unterlegscheibe, Außendurchmesser $\approx 3x$ Gewindedurchmesser / A2-AISI 304

Washers with outside diameter $\approx 3x$ nominal thread diameter / Rondelles, diamètre extérieur $\approx 3x$ diamètre nominal de filetage

DIN 9021

Artikel-Nr. Item-no.	Innendurchmesser Inside diameter	Außendurchmesser Outside diameter	S	Box
9021284	8,4	24	2	500
90212105	10,5	30	2,5	500
90212130	13	37	3	200
90212170	17	50	3	100
90212200	20	56	4	100
90212220	22	60	4	50



Weitere Größen verfügbar / Other sizes available / Autres tailles disponibles

Rosette, gestanzt / A2-AISI 304

Stamped cup washers / Rondelle Cuvette emboutie

NFE27-619

Artikel-Nr. Item-no.	Innendurchmesser Inside diameter	Außendurchmesser Outside diameter	S	Box
2761928	9	22,0	0,30	500
27619210	11	28,0	0,30	200
27619212	14	32,0	0,40	200

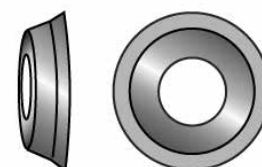

Weitere Größen verfügbar / Other sizes available / Autres tailles disponibles

DIN 571

Sechskant-Holzschrauben / A2-AISI 304
Hexagon head wood screws / Vis à bois hexagonales



Artikel-Nr. Item-no.	Abmessungen Dimensions	Antrieb Drive	Box
057128 40	8x40	SW13	100
057128 45	8x45	SW13	100
057128 50	8x50	SW13	100
0571210 50	10x50	SW17	100
0571210 60	10x60	SW17	100
0571210 80	10x80	SW17	100
0571210 100	10x100	SW17	50
0571210 130	10x130	SW17	50
0571210 150	10x150	SW17	50
0571210 180	10x180	SW17	50
0571210 200	10x200	SW17	50
0571210 150	10x250	SW17	25
0571210 300	10x300	SW17	25
0571212 100	12x100	SW19	50
0571212 120	12x120	SW19	25
0571212 140	12x140	SW19	25
0571212 160	12x160	SW19	25
0571212 180	12x180	SW19	25
0571212 200	12x200	SW19	25
0571212 250	12x250	SW19	25
0571212 300	12x300	SW19	25

Weitere Größen verfügbar / Other sizes available / Autres tailles disponibles

Art. 9044

Spannplattenschraube Senkkopf mit Bohrspitze / A2-AISI 304
SP-Drill CSK head timber screws, drilling-point / Vis TF pour agglomérés SP-Drill autoperceuse

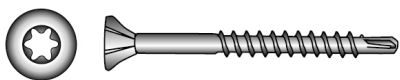

Artikel-Nr. Item-no.	Abmessungen Dimensions	Antrieb Drive	Box
9044245 50	4,5x50/30	TX20	200
9044245 70	4,5x70/50	TX20	200
9044250 60	5,0x60/36	TX25	200
9044250 80	5,0x80/54	TX25	200
9044250 100	5,0x100/60	TX25	200
9044260 80	6,0x80/54	TX25	200
9044260 100	6,0x100/60	TX25	100
9044260 120	6,0x120/70	TX25	100
9044260 140	6,0x140/70	TX25	100

Weitere Größen verfügbar / Other sizes available / Autres tailles disponibles

Holzschraube Senkkopf TX25 / A2-AISI 304

Double countersunk head timber screws / Vis pour agglomérés à tête fraisée renforcée

Art. 9047

Artikel-Nr. Item-no.	Abmessungen Dimensions	Antrieb Drive	Box
9047250 40	5,0x40/24	TX25	200
9047250 50	5,0x50/3	TX25	200
9047250 80	5,0x80/48	TX25	100
9047250 100	5,0x100/60	TX25	100
9047260 60	6,0x60/36	TX25	100
9047260 80	6x80/48	TX25	100
9047260 100	6x100	TX25	100
9047260 150/70	6x150/70	TX25	100

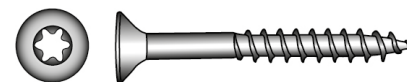

Weitere Größen verfügbar / Other sizes available / Autres tailles disponibles

Spenglerschrauben / A2-AISI 304

RSD CSK woodscrews / Vis de Rive 2 pces avec EPDM

Art. 9087

Artikel-Nr. Item-no.	Abmessungen Dimensions	Farbe Color	Box
9087222901045 120	4,5x120	weiß	100
9087222701645 120	4,5x120	anthrazitgrau	100
9087222300945 120	4,5x120	oxidrot	100

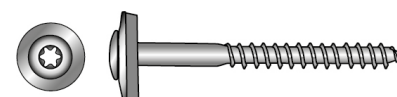

Weitere Größen verfügbar / Other sizes available / Autres tailles disponibles

Seko-Holzbauschrauben mit Fräsrippen, Schneidkerbe / A2-AISI 304

Double CSK head timber screws, ribs, cutting point / Vis TF pour aggl. nervures de fraisage, point cut

Art. 9147

Artikel-Nr. Item-no.	Abmessungen Dimensions	Antrieb Drive	Box
9147240 40/24	4x40/24	TX-20	200
9147240 50/30	4x50/30	TX20	200
9147250 60/36	5x60/36	TX25	100
9147250 80/48	5x80/48	TX25	100
9147280 80/50	8x80/50	TX40	100
9147280 100/80	8x100/80	TX40	100
9147280 120/80	8x120/80	TX40	100
9147280 140/80	8x140/80	TX40	100

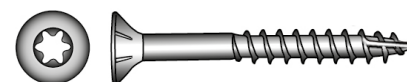

Weitere Größen verfügbar / Other sizes available / Autres tailles disponibles

Tellerkopf-Holzschraube mit Schneidkerbe / A2-AISI 304

Pan washer head timber screws with cutting point / Vis à bois à tête plate pointée Cut

Art. 9250

Artikel-Nr. Item-no.	Abmessungen Dimensions	Antrieb Drive	Box
9250260 50/30	6x50/30	TX25	100
9250260 60/36	6x60/36	TX25	100
9250260 80/48	6x80/48	TX25	100
9250260 100/70	6x100/70	TX25	100
9250280 80/72	8x80/72	TX40	100
9250280 110/80	8x110	TX40	100
9250280 130/80	8x130	TX40	50
9250280 150/80	8x150/80	TX40	50

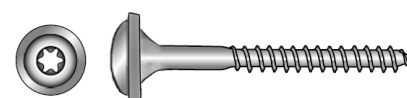

Weitere Größen verfügbar / Other sizes available / Autres tailles disponibles

Art. 9145

Einschlagstopfen für Innensechskantantrieb / A1-AISI 303

Drive-in plugs for hexagon socket drive / Obturateur pour empreinte HC

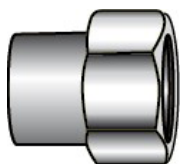

Artikel-Nr. Item-no.	Abmessungen Dimensions	Box
914514	SW4	100
914515	SW5	100
914516	SW6	100
914518	SW8	100

814733

Bit-Sortiment 1/4" 122-tlg / Chrom Vanadium

Bit assortment 1/4" 122 pcs. / Boîte d'embouts, 1/4" 122 pcs.



Artikel-Nr. Item-no.	Box
81473310122	1

Inhalt:

- 1/4" Bit-Schraubendreher / ERGOTORQUE Bit screwdriver
- 1/4" Bithalter magnetisch / Bit holder, magnetic
- 1/4" Steckadapter: 25mm; 50mm / Square drive adaptor, for bit ratchet
- 1/4" Bit-Adapter-Stecknuss Chrom / CHROMEplus Bit adaptor socket
- 1/4" Bit Flügelmutter / Bit wing nut
- 1/4" Sechskantnuss/ Hexagon nut bit: 4mm; 5mm; 6mm; 7mm; 8mm; 9mm; 10mm; 11mm; 12mm; 13mm
- 1/4" Sechskantnuss magnetisch/ Hexagon nut magnetic: 5/32"; 3/16"; 7/32"; 1/4"; 9/32"; 5/16"; 11/32"; 3/8"; 7/16" 1/2"
- 1/4" Bit Schlitz / Bit slot: 3mm; 4mm; 4,5mm; 5mm; 5,5mm; 6mm; 6,5mm; 7mm; 8mm
- 1/4" Bit Phillips / Bit phillips: PH00; PH0; PH1; PH2; PH3
- 1/4" Bit Pozi / Bit pozi: PZ00; PZ0; PZ1; PZ2; PZ3
- 1/4" Bit Innensechskant / Bit hexagon: 1,5mm; 2mm; 2,5mm; 3mm; 4mm; 5mm; 5,5mm; 6mm; 8mm
- 1/4" Bit Innensechskant mit Bohrung / Bit hexagon secure: 2mm; 2,5mm, 3mm; 4mm; 5mm; 6mm
- 1/4" Bit TX / Bit TX: T5; T6; T7; T8; T9; T10; T15; T20; T20; T25; T27; T30; T40; T45
- 1/4" Bit TX mit Bohrung / Bit TX secure: TB8; TB10; TB15; TB20; TB25; TB27; TB30; TB35; TB40
- 1/4" Bit XZN / Bit XZN: M5; M6; M8
- 1/4" Bit Torque / Bit torque: 6mm; 8mm; 10mm
- 1/4" Bit Spanner / Spanner bit : 4mm; 6mm; 8mm; 10mm
- 1/4" Bit Triwing / Bit Triwing: 4mm #1; 6mm #2; 8mm #3; 10mm #4
- 1/4" Bit Doppelkeil / Dual wing bit : #1; #2; #3
- 1/4" Bit Vierkant / Bit square: #0; #1; #2; #3
- 1/4" Bit Sechskant / Bit hexagon: 1/16"; 5/64"; 3/32"; 7/64"; 1/8"; 9/64"; 5/32"; 3/16"; 7/32"; 1/4"
- 1/4" Bit 5-Stern mit Bohrung/ Bit tamperproof five star: TS10; TS15; TS20; TS25; TS27; TS30; TS40; TS45; TS50

Bit-Sortiment Edelstahl 1/4" 18-tlg. / A2-AISI 304
 Bit assortment stainless steel 1/4" 18 pcs. / Boîte d'embouts en acier inox 1/4" 18 pcs.

814734

Artikel-Nr. Item-no.	Box
814734218	1

Inhalt:

- 1/4" Edelstahl Bithalter magnetisch / STAINLESS STEEL quick release bit holder
- 1/4" Edelstahl Bit Pozi: PZ1; PZ2; PZ3 / STAINLESS STEEL bit PZ: PZ1; PZ2; PZ3
- 1/4" Edelstahl Bit Phillips: PH1; PH2; PH3 / STAINLESS STEEL bit PH: PH1; PH2; PH3
- 1/4" Edelstahl BitTX: T10; T15; T20; T25; T30; T40 / STAINLESS STEEL bit Torx: T10; T15; T20; T25; T30; T40
- 1/4" Edelstahl Bit Innensechskant: 4mm; 5mm; 6mm / STAINLESS STEEL bit hexagon: 4mm; 5mm; 6mm
- 1/4" Edelstahl Bit Schlitz: 5,5mm; 6,5mm / STAINLESS STEEL bit for slotted screws: 5,5mm; 6,5mm



Bithalter Edelstahl magnetisch 1/4" / A2-AISI 304
 Magnetic stainless steel bit holder 1/4" / Porte-embout magnétique de acier inox 1/4"

814999

Artikel-Nr. Item-no.	Box
814999214	1



Edelstahl-Bit 1/4" / A2-AISI 304
 Stainless steel bit 1/4" / Embout pour vis de acier inox 1/4"

815000

Artikel-Nr. Item-no.	Antrieb Drive	Box
8150002PH1	PH1	5
8150002PH2	PH2	5
8150002PH3	PH3	5
8150002PZ1	PZ1	5
8150002PZ2	PZ2	5
8150002PZ3	PZ3	5
8150002TX10	TX10	5
8150002TX10PIN	TX10 Pin	5
8150002TX15	TX15	5
8150002TX15PIN	TX15 Pin	5
8150002TX20	TX20	5
8150002TX20PIN	TX20 Pin	5
8150002TX25	TX25	5
8150002TX25PIN	TX25 Pin	5
8150002TX30	TX30	5
8150002TX30PIN	TX30 Pin	5
8150002TX40	TX40	5
8150002TX40PIN	TX40 Pin	5
8150002SW4	SW4	5
8150002SW5	SW5	5
8150002SW6	SW6	5
8150002SZ55	SZ5,5	5
8150002SZ65	SZ6,5	5





***Marinotech Edelstahlhandel
GmbH & Co. KG***

Marschgehren 16 · 28779 Bremen
Deutschland / Germany

Tel. +49 421 - 69056 - 0
Fax +49 421 - 69056 - 50
info@marinotech.de

» ***www.marinotech.shop***

» ***www.marinotech.de***

Folgen Sie uns auch auf

